

proceq

🇨🇭 Solutions since 1954

equotip[®]

Portable Hardness Testing Leeb – Rockwell – UCI

تامین کننده تجهیزات بازرسی فنی
و کنترل کیفیت در ایران

کاوشکاران

تلفن: ۰۲۱ - ۸۸۶۸ ۵۲۹۷

www.KAWOSHKARAN.com



Patent pending

ASTM

DIN

EN

ISO

GB/T

JB/T



Interactive

Measuring Performance

- High accuracy
- Custom conversions
- Combined methods

Powerful Hardware

- Rugged housing
- High capacity battery
- Versatile connectivity



Ease of Use

- Large touchscreen
- Personalized views
- Custom reports

equotip[®]

The All-In-One Portable Hardness Testing Solution

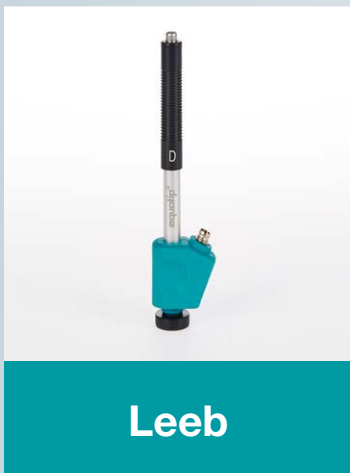

Leeb

[Find out more](#)
(Page 5)



**Portable
Rockwell**

[Find out more](#)
(Page 7)



UCI

[Find out more](#)
(Page 9)

Covering Broad Application Range



Av. Roughness R_a (μm / μinch)
 Min. Mass (kg / lbs)
 Min. Thickness (mm / inch)

	Leeb	Portable Rockwell	UCI
	Dynamic Rebound	Static Rockwell	Ultrasonic Contact Impedance Method
Av. Roughness R_a (μm / μinch)	7 / 275	2 / 80	12.5 / 500
Min. Mass (kg / lbs)	0.02 / 0.045	No requirement	0.3 / 0.66
Min. Thickness (mm / inch)	1 / 0.04	10 x ind. depth	5 / 0.2

Oil & Gas



Weld, Base Material & HAZ
Pressure Vessels
Flanges
Pipes
Wellhead Equipment

Weld, Base Material & HAZ	○	●	○	●
Pressure Vessels	○	●	○	●
Flanges	●	○	●	○
Pipes	○	●	○	●
Wellhead Equipment	○	●	○	●

Automotive



Engine Blocks
Shafts
Panels
Gears
Brake Systems

Engine Blocks	●	○	○	○
Shafts	●	○	○	○
Panels	○	○	○	○
Gears	●	○	○	○
Brake Systems	○	○	○	○

Aerospace



Turbine Blades
Casings / Housings
Panels
Cast Objects
Landing Gears

Turbine Blades	○	○	○	○
Casings / Housings	○	○	○	○
Panels	○	○	○	○
Cast Objects	○	○	○	○
Landing Gears	○	○	○	○

Manufacturing and Machinery



Rolls
Coils
Bars / Pipes
Heat Treatment / Casting
Wires

Rolls	○	○	○	○
Coils	○	○	○	○
Bars / Pipes	○	○	○	○
Heat Treatment / Casting	○	○	○	○
Wires	○	○	○	○

Combining methods

Extends the application range to confined spaces, non-ideal samples and for correlating one method with another.

○ Leeb & Portable Rockwell
 ○ UCI & Portable Rockwell

Equotip® 550 Touchscreen Unit Built for Demanding Environments

Scratch-resistant solid touchscreen
with Gorilla® Glass technology



Shock-absorbing, dust and water proof
(IP 54) rugged housing



Functional at a wide temperature range
from -10 °C to +50 °C

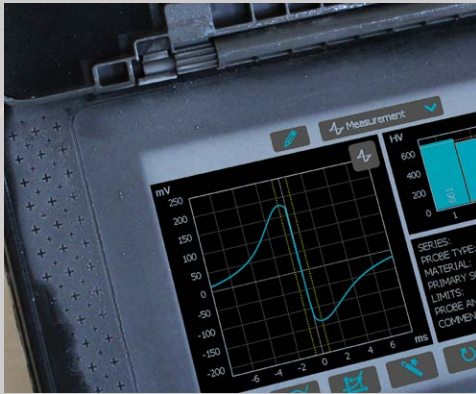

Connectors and circuits are protected
against dust and voltage spikes



Standards

ASTM A956 / A370

ISO EN 16859

DIN 50156

GB/T 17394

JB/T 9378

Conversion Standards

ASTM E140

Guidelines

ASME CRTD-91

DGZfP Guideline MC 1

VDI / VDE Guideline 2616 Paper 1

Nordtest Technical Reports

99.12, 99.13, 99.36



Equotip® 550 Leeb

The global industry standard

Highly accurate ±4 HL



Wide Measurement Range

Leeb impact devices are best suited for on-site testing of heavy, large or already installed parts.



Impact Devices & Accessories

Proceq offers a wide variety of impact devices along with support rings to serve most hardness testing requirements.



Broad Hardness Scales Coverage

The measurements are automatically converted to all common hardness scales (HV, HB, HRC, HRB, HRA, HS) as required.



Test Blocks Portfolio

Extensive range of precise hardness test blocks available for each impact device with different hardness levels for regular verification.

Equotip Test Blocks Flyer





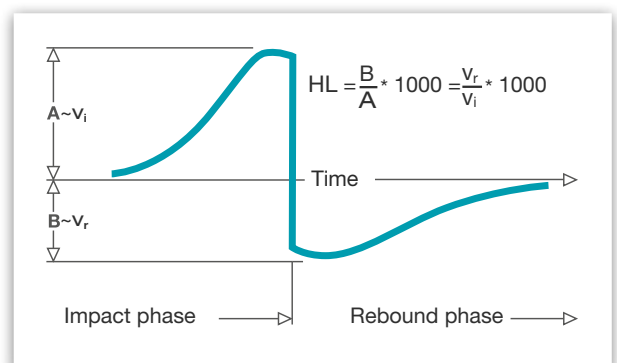

The Leeb Measuring Principle – Invented by Proceq

Leeb hardness principle is based on the dynamic (rebound) method. An impact body with a hard metal test tip is propelled by spring force against the surface of the test piece. Surface deformation takes place when the impact body hits the test surface, which results in loss of kinetic energy. This energy loss is detected by a comparison of velocities v_i and v_r when the impact body is at a precise distance from the surface for both the impact and rebound phase of the test, respectively.

Velocities are measured using a permanent magnet in the impact body that generates an induction voltage in the coil which is precisely positioned in the impact device. The detected voltage is proportional to the velocity of the impact body. Signal processing is then providing the hardness reading.



Equotip® Leeb Impact Devices

									
			D/DC	DL	S	E	G	C	
Impact energy			11 Nmm	11 Nmm	11 Nmm	11 Nmm	90 Nmm	3 Nmm	
Indenter			Tungsten carbide 3 mm	Tungsten carbide 2.8 mm	Ceramics 3 mm	Polycrystalline diamond 3 mm	Tungsten carbide 5 mm	Tungsten carbide 3 mm	
Scope			Most commonly used probe. For the majority of applications.	Narrow indenter (probe) tip for measurement on hard reach areas or spaces with limited access.	For measurements in extreme hardness ranges. Tool steels with a high carbide content.	For measurements in extreme hardness ranges. Tool steels with high carbide content.	Large and heavy components, e.g. casts and forged parts.	For surface hardened components, coatings, thin or impact-sensitive parts.	
Test blocks			<500 HLD ~600 HLD ~775 HLD	<710 HLDL ~780 HLDL ~890 HLDL	<815 HLS ~875 HLS	~740 HLE ~810 HLE	~450 HLG ~570 HLG	~565 HLC ~665 HLC ~835 HLC	
Measuring Range	Steel and cast steel	Vickers Brinell Rockwell Shore Rm N/mm ²	HV HB HRB HRC HRA HS σ1 σ2 σ3	81-955 81-654 38-100 20-68 30-99 275-2194 616-1480 449-847	80-950 81-646 37-100 21-68 31-97 275-2297 614-1485 449-849	101-964 101-640 22-70 61-88 28-104 340-2194 615-1480 450-846	84-1211 83-686 20-72 61-88 29-103 283-2195 616-1479 448-849	90-646 48-100 305-2194 618-1478 450-847	81-1012 81-694 20-70 30-102 275-2194 615-1479 450-846
	Cold work tool steel	Vickers Rockwell	HV HRC	80-900 21-67	80-905 21-67	104-924 22-68	82-1009 23-70	*	98-942 20-67
	Stainless steel	Vickers Brinell Rockwell	HV HB HRB HRC	85-802 85-655 46-102 20-62	*	119-934 105-656 70-104 21-64	88-668 87-661 49-102 20-64	*	*
	Cast iron lamellar graphite GG	Brinell Vickers Rockwell	HB HV HRC	90-664 90-698 21-59	*	*	*	92-326	*
	Cast iron, nodular graphite GGG	Brinell Vickers Rockwell	HB HV HRC	95-686 96-724 21-60	*	*	*	127-364 19-37	*
	Cast aluminium alloys	Brinell Vickers Rockwell	HB HV HRB	19-164 22-193 24-85	20-187 21-191	20-184 22-196	23-176 22-198	19-168 24-86	21-167 23-85
	Copper/zinc alloys (brass)	Brinell Rockwell	HB HRB	40-173 14-95	*	*	*	*	*
	CuAl/CuSn-alloys (bronze)	Brinell	HB	60-290	*	*	*	*	*
	Wrought copper alloys, low alloyed	Brinell	HB	45-315	*	*	*	*	*
Test Piece Requirements	Surface preparation	Roughness grade class ISO 1302	N7				N9	N5	
		Max. roughness depth R _t (µm / µinch)	10 / 400				30 / 1200	2.5 / 100	
		Average roughness R _a (µm / µinch)	2 / 80				7 / 275	0.4 / 16	
	Minimum sample mass	Of compact shape (kg / lbs)	5 / 11				15 / 33	1.5 / 3.3	
		On solid support (kg / lbs)	2 / 4.5				5 / 11	0.5 / 1.1	
		Coupled on plate (kg / lbs)	0.05 / 0.2				0.5 / 1.1	0.02 / 0.045	
	Minimum sample thickness	Uncoupled (mm / inch)	25 / 0.98				70 / 2.73	15 / 0.59	
		Coupled (mm / inch)	3 / 0.12				10 / 0.4	1 / 0.04	
		Surface layer thickness (mm / inch)	0.8 / 0.03					0.2 / 0.008	
	Indentation size on test surface	With 300 HV, 30 HRC	Diameter (mm / inch)	0.54 / 0.021				1.03 / 0.04	0.38 / 0.015
Depth (µm / µinch)			24 / 960				53 / 2120	12 / 480	
With 600 HV, 55 HRC		Diameter (mm / inch)	0.45 / 0.017				0.9 / 0.035	0.32 / 0.012	
		Depth (µm / µinch)	17 / 680				41 / 1640	8 / 2560	
With 800 HV, 63 HRC		Diameter (mm / inch)	0.35 / 0.013					0.30 / 0.011	
		Depth (µm / µinch)	10 / 400					7 / 280	

*Custom conversion curve / correlation

Equotip® 550 Portable Rockwell

Standards

DIN 50157

Conversion Standards

ASTM E140

ISO EN 18265

Guidelines

DGZfP Guideline MC 1

VDI / VDE Guideline 2616 Paper 1



*World-Class
Portable Static
Hardness Testing*



Advanced algorithm option
for faster measurement



Probe can be connected
directly to PC



Specially For Thin Parts

Particularly suited for scratch-sensitive and polished parts or on thin parts, profiles and pipes. The required minimum thickness for a reliable hardness reading is ten times the indentation depth. For the mass there is no minimum requirement.



Suits Various Sample Geometries

Unique measuring clamp and support feet are available for the probe allowing tests to be carried out on various geometries.

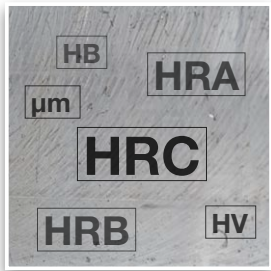

Broad Hardness Scales Coverage

Measurements in HRC and HV with automatic integrated conversions to HB, HRA, HRB and many more common scales in compliance to ASTM E140 and ISO 18265.



For Any Environment

The Equotip 550 Portable Rockwell can be utilized for on-site, factory and lab environment with almost no limitation.

The Rockwell Measuring Principle

The test principle of the Equotip Portable Rockwell follows the traditional Rockwell static test method. During measurements with the Equotip Portable Rockwell Probe, a diamond indenter is forced into the test piece using a precisely controlled force. The indentation depth of the diamond is continuously measured while a load is applied and released. From the indentation depths d_1 and d_2 recorded at two defined loads, the difference is calculated: $\Delta = d_2 - d_1$. This is traditionally referred to as plastic deformation.

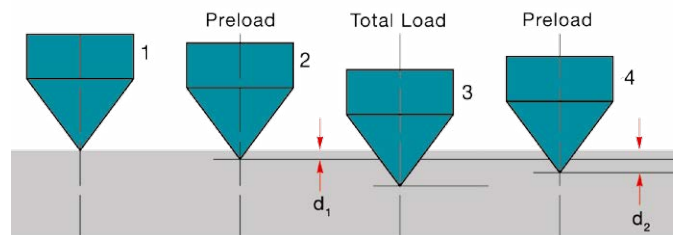

Equotip® Portable Rockwell Probe and Accessories

	Measuring range	0-100 µm; 19-70 HRC; 35-1'000 HV
	Resolution	0.1 µm; 0.1 HRC; 1 HV
	Measuring accuracy	± 0.8 µm; ~ ± 1.0 HRC over entire range
	Test loads	Preload 10 N / Total Load 50 N
	Diamond indenter	Angle 100.0° ± 0.5°, diameter of flat area of 60 µm ± 0.5 µm
	Dimensions	Ø 40 mm, Length 115 mm

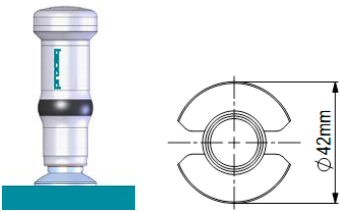
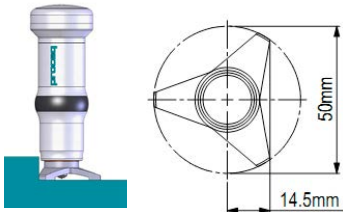
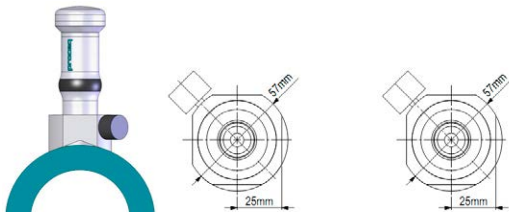
		
<p>Round standard foot (magnetic) Ideal for flat parts, and test locations more than 10 mm from an edge.</p>	<p>Tripod foot Designed for tests that require accurate positioning (welds, heat-affected zones).</p>	<p>Special feet RZ 18-70 and 70-∞ Designed for curved test pieces such as cylindrical parts, tubes, pipes.</p>

The Portable Rockwell Measuring Clamp

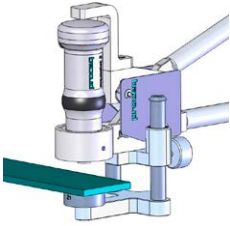
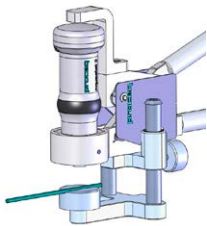
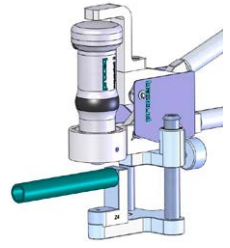
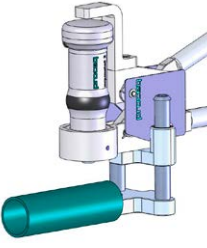

<p>Clamp Adapters</p>	
	
<p>Support Z1 for flat parts max. 40 mm thickness</p>	<p>Support Z2 for thin cylindrical parts, wires, bolts min. Ø 3 mm</p>
	
<p>Support Z4 for tubes and pipes up to Ø 28 mm</p>	<p>Support Z4+28 for tubes and pipes over Ø 28 mm</p>

Equotip® 550 UCI

Standards

ASTM A1038

DIN 50159

Conversion Standards

ASTM E140

ISO 18265

Guidelines

DGZfP Guideline MC 1

VDI / VDE Guideline 2616 Paper 1

ASME CRTD-91



*Most Flexible
and Convenient
Ultrasonic Hardness Tester*

 **One-Step Calibration**

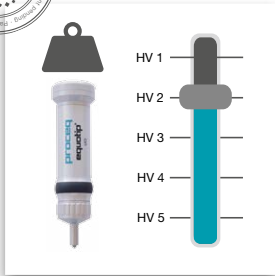

Adjustable test load

With this unique and patented feature a wide range of applications can be covered offering test loads ranging from HV1 to HV5, eliminating the need to purchase more than one UCI probe.



Quick & Reliable Measurements

User guidance enables reliable and accurate hardness readings to be obtained quickly and easily.

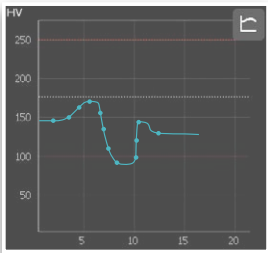

Unique Software Features

Additional features such as the profile view and industry specific settings allow for a very smooth workflow.



Broad Hardness Scales Coverage

Measurements in HV with automatic integrated conversions to HB, HRA, HRB, HRC and many more common scales in compliance to ASTM E140 and ISO 18265.

The UCI Measuring Principle

The UCI (Ultrasonic Contact Impedance) method uses the same pyramid-shaped diamond as a conventional Vickers hardness tester. Unlike Vickers testing, no optical evaluation of the indentation is required, enabling fast and portable measurements. The UCI method excites a rod into an ultrasonic oscillation. The test load is applied by a spring and typically ranges from 1 to 5 kg of force (HV1 – HV5). As the diamond is forced into the material, the frequency of the rod oscillation changes in response to the contact area between the diamond and the material under test. The instrument detects the shift in frequency, converts it to a hardness value which is immediately displayed on the screen.

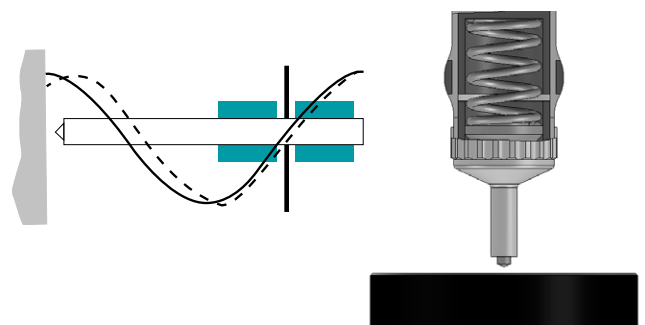

Equotip® UCI Probe and Accessory



Measuring range	20 – 2000 HV
Resolution	1 HV (UCI), 0.1 HRC
Measuring accuracy	± 2 % (150 – 950 HV)
Test loads (in 10 N steps)	Selectable: HV1, HV2, HV3, HV4, HV5
Diamond indenter	Vickers diamond according to ISO 6507-2
Dimensions	155 x ø 40 mm (6.1 x ø 1.57 inches) without foot

Adjustable test load

The required test load can be selected by the user in the settings menu. For each measurement series, the force can be chosen from five levels between HV1 and HV5 (~10 N and ~50 N), to fit a wide range of applications. The minimum required mass for reliable UCI measurements is 0.3 kg (0.66 lbs), and a thickness of at least 5 mm (0.2 inch).

Examples:

HV1	Precision parts, thin coatings, hardened layers
HV5	Large components, HAZ, forging parts

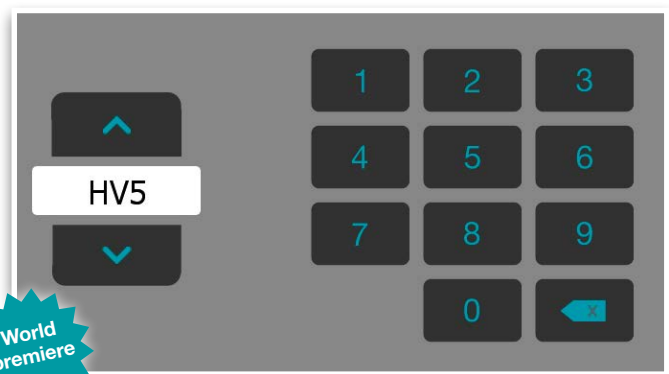

Special Foot

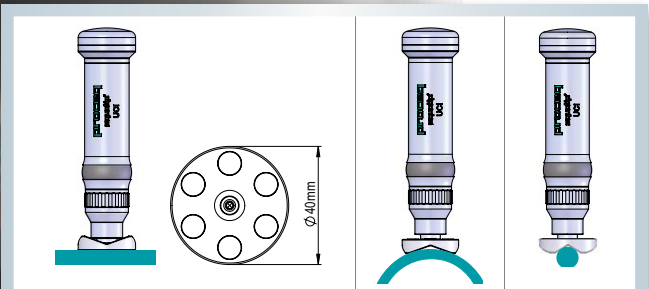

The optionally available special foot increases the measurement repeatability. It can be used for flat or curved surfaces. For curved surfaces there are two different apertures, one for diameters from 5 to 25 mm and one for larger diameters from 20 to 70 mm.

Equotip® 550 Touchscreen Unit

Unique Features

Equotip 550 takes advantage of a new generation full color, dual processor Touchscreen Unit with enhanced software capabilities. The instrument offers a unique range of functions which ultimately help speed up on-site and laboratory inspections and analysis.



Best-in-class reliability arising from 40 years of experience

Equotip solutions are recognised worldwide for providing best-in-class durability, high long-term accuracy and premium service.



Increased accuracy through conversion curve options

Select from preloaded established conversions. Create, edit and verify material conversion curves directly on the instrument (one-point, two-point shift or polynomial). PC software allows to share conversions with customers, suppliers and associated companies.



Reduce incorrect measurements with interactive guides

Intelligent on-screen notifications to obtain the most relevant settings for any application and to recognize and prevent faulty usage.



Time saving through customized reports

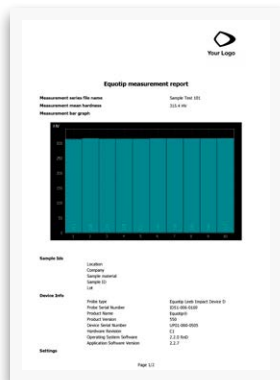

The Equotip 550 allows to easily create pdf reports on-site directly on the instrument and export to a USB stick.

The reports can be fully configured and enhanced with customer specific information and company logo.

Equotip® 550 Touchscreen Unit

Unique Features



Traceable precision by verification management

Step by step verification wizard in line with applicable standards helps to regularly check the proper functioning of the instrument over time.



Optimized production process with automation package



Comprehensive software tools and libraries help to easily include the Equotip 550 into existing production chains. Feed the measurement results directly into data management systems.



Reduced costs due to a future proof all-in-one solution

The high versatile Equotip 550 gives the possibility to apply three measuring principles and to connect nine different probes to only one device. There is no need to buy several instruments from now on.



Enlarged application range by combining methods

The step by step combined method wizard allows automatic on-site correlation of two different measuring principles to reduce dependencies on material and geometries.

Equotip® 550 Touchscreen Unit

Unmatched User Experience

Touchscreen Features

For simplified and improved usability on high resolution display



Personalized Screens
Arrange the view according to your needs

Elaborated User Interface
Designed by industry experts for smooth operation

Display	7" color display 800x480 pixels
Memory	Internal 8 GB flash memory
Regional Settings	Metric and Imperial units, multi-language and timezone supported
Power Input	12 V +/-25 % / 1.5 A
Connectors	Probe, USB host / device and Ethernet
Dimensions	250 x 162 x 62 mm
Weight	1525 g (incl. Battery)

Battery	3.6 V, 14.0 Ah
Battery Lifetime	> 8 h (in standard operating mode)
Humidity	< 95 % RH, non condensing
Operating Temperature	-10 °C to +50 °C
IP	54
Certification	CE

Proceq – A Story of Success over more than 60 Years



proceq
Precision since 1954

Market Leader

Proceq SA, founded 1954 in Switzerland, is the global leader in portable measurement solutions for the non-destructive testing of material properties of metal, concrete, rock, paper and composites.

 [Find out more on the Proceq history](#)

INVENTOR OF LEEB

INDUSTRY STANDARD

NON-DESTRUCTIVE

equotip®

INVENTED IN 1975

PORTABLE

LEEBS

ROCKWELL

UCI



Worldwide Local Support

Our team of dedicated experts are available to advise you on our instruments and their applications. In addition you may take further benefits from our instructional videos, evaluation tools, online webinars and of course our live seminars globally.



ISO
9001

Swiss Made

Proceq instruments are developed, designed and manufactured in Switzerland. Since 1994, Proceq has been certified to the ISO 9001 standards that guarantee highest quality of processes, products and services.



Experience

Proceq has been a proud innovator in the field of portable non-destructive testing, developing solutions that have conquered the inspection industry for decades. Most famous brands are Equotip®, Schmidt®, Pundit®, Profometer® and Carboteq®.

New Equotip 550 Interactive Animation

Simulate a real measurement situation right now! Get an insight into the software features, unique user interface and innovative wizards!



[Click here to start the interactive Equotip Demo!](#)





Overcome the limitations of stationary hardness testing

- 100% portable and extremely flexible
- No interruptions in production due to 24h availability
- Equally reliable, accurate and standardized



Prepacked Units

All units include: Equotip Touchscreen incl. Battery, Power Supply, USB Cable, Surface Roughness Comparator Plate, DVD with Software, Documentation, Carrying Strap and Carrying Case

Equotip® 550	Equotip® 550 Leeb D	Equotip® 550 Leeb G	Equotip® 550 Portable Rockwell	Equotip® 550 UCI
356 10 001	356 10 002	356 10 003	356 10 004	356 10 005
				
For flexible probe configuration and for existing owners of Equotip and Equostat 3 probes	Additionally includes Equotip Leeb Impact Device D, Impact Device Cable, Test Block ~775 HLD / ~56 HRC, Coupling Paste, Cleaning Brush	Additionally includes Equotip Leeb Impact Device G, Impact Device Cable, Test Block ~570 HLG / ~340 HB, Coupling Paste, Cleaning Brush	Additionally includes Equotip Portable Rockwell Probe 50 N, Protective Rubber Sleeve, Probe Cable, Test Block ~62 HRC	Additionally includes Equotip UCI Probe HV1-HV5, UCI Probe Cable, UCI Test Block ~850 HV

2-in-1 Kits Special Offers

356 10 020: Equotip 550 Portable Rockwell & UCI Kit
 356 10 021: Equotip 550 Portable Rockwell & Leeb D Kit
 356 10 022: Equotip 550 Leeb D & UCI Kit

Impact Devices & Probes

Equotip Leeb Impact Devices

356 00 500	Equotip Leeb Impact Device C
356 00 100	Equotip Leeb Impact Device D
356 00 110	Equotip Leeb Impact Device DC
356 00 120	Equotip Leeb Impact Device DL
356 00 400	Equotip Leeb Impact Device E
356 00 300	Equotip Leeb Impact Device G
356 00 200	Equotip Leeb Impact Device S

Equotip Portable Rockwell Probe

356 00 600	Equotip Portable Rockwell Probe 50N (for Equotip 550 or PC)
------------	---

Equotip UCI Probe

356 00 700	Equotip UCI Probe HV1-HV5
------------	---------------------------

Accessories

Equotip Leeb Accessories

353 03 000	Set of Support Rings
356 00 080	Equotip Impact Device Cable 1.5 m (5 ft)
353 00 086	Equotip Impact Device Cable 5 m (15 ft)

Equotip Portable Rockwell Accessories

354 01 200	Equotip Portable Rockwell Measuring Clamp
354 01 130	Equotip Portable Rockwell Tripod
354 01 250	Equotip Portable Rockwell Special Foot RZ 18 - 70
354 01 253	Equotip Portable Rockwell Special Foot RZ 70 - ∞
354 01 243	Equotip Portable Rockwell support Z2 for measuring clamp
354 01 229	Equotip Portable Rockwell Support Z4+28 for measuring clamp (for tubes and pipes over Ø 28 mm)
354 01 228	Equotip Portable Rockwell support Z4 for measuring clamp (for tubes and pipes up to Ø 28 mm)

Equotip UCI Accessories

356 00 720	Equotip UCI Special Foot
------------	--------------------------

Ordering Information



Test Blocks

Equotip Leeb Test Blocks Calibrated by Proceq

357 11 500	Equotip Test Block C, ~565 HLC / <220 HB
357 12 500	Equotip Test Block C, ~665 HLC / ~325 HB
357 13 500	Equotip Test Block C, ~835 HLC / ~56 HRC
357 11 100	Equotip Test Block D/DC, <500 HLD / <220 HB
357 12 100	Equotip Test Block D/DC, ~600 HLD / ~325 HB
357 13 100	Equotip Test Block D/DC, ~775 HLD / ~56 HRC
357 13 105	Equotip Test Block D/DC, ~775 HLD, one side
357 11 120	Equotip Test Block DL, <710 HLDL / <220 HB
357 12 120	Equotip Test Block DL, ~780 HLDL / ~325 HB
357 13 120	Equotip Test Block DL, ~890 HLDL / ~56 HRC
357 13 400	Equotip Test Block E, ~740 HLE / ~56 HRC
357 14 400	Equotip Test Block E, ~810 HLE / ~63 HRC
357 31 300	Equotip Test Block G, <450 HLG / <200 HB
357 32 300	Equotip Test Block G, ~570 HLG / ~340 HB
357 13 200	Equotip Test Block S, ~815 HLS / ~56 HRC
357 14 200	Equotip Test Block S, ~875 HLS / ~63 HRC

Equotip Portable Rockwell Test Blocks

357 41 100	Equotip Portable Rockwell Test Block ~20 HRC, ISO 6508-3 HRC Calibration
357 42 100	Equotip Portable Rockwell Test Block ~45 HRC, ISO 6508-3 HRC Calibration
357 44 100	Equotip Portable Rockwell Test Block ~62 HRC, ISO 6508-3 HRC Calibration

Equotip UCI Test Blocks

357 51 100	Equotip UCI Test Block ~300HV, ISO 6507-3 HV5 Calibration
357 52 100	Equotip UCI Test Block ~550HV, ISO 6507-3 HV5 Calibration
357 54 100	Equotip UCI Test Block ~850HV, ISO 6507-3 HV5 Calibration

Additional Test Block Calibrations

Factory Calibrations by Proceq

357 10 109	Equotip Leeb Test Block Additional Calibration HLD / HLDC
357 10 129	Equotip Leeb Test Block Additional Calibration HLDL
357 10 209	Equotip Leeb Test Block Additional Calibration HLS
357 10 409	Equotip Leeb Test Block Additional Calibration HLE
357 10 509	Equotip Leeb Test Block Additional Calibration HLC
357 30 309	Equotip Leeb Test Block Additional Calibration HLG

By Accredited Institutes

357 90 909	Equotip Leeb Test Block Additional Calibration HL (DIN 50156-3)
357 90 919	Equotip Leeb Test Block Additional Calibration HB (ISO 6506-3)
357 90 929	Equotip Leeb Test Block Additional Calibration HV (ISO 6507-3)
357 90 939	Equotip Leeb Test Block Additional Calibration HR (ISO 6508-3)

By Accredited Institutes

357 90 918	Equotip Portable Rockwell Test Block Additional Calibration HB (ISO 6506-3)
357 90 928	Equotip Portable Rockwell Test Block Additional Calibration HV (ISO 6507-3)

By Accredited Institutes

357 90 940	Equotip UCI Test Block Additional Calibration HB, ISO 6506-3
357 90 941	Equotip UCI Test Block Additional Calibration HR, ISO 6508-3
357 90 942	Equotip UCI Test Block Additional Calibration HV1, ISO 6507-3

Service and Support

Proceq is committed to providing the best support and service available in the industry through the Proceq certified service centers worldwide. This results in a complete support for Equotip by means of our global service and support facilities.

Subject to change without notice. All information contained in this documentation is presented in good faith and believed to be correct. Proceq SA makes no warranties and excludes all liability as to the completeness and/or accuracy of the information. For the use and application of any product manufactured and/or sold by Proceq SA explicit reference is made to the particular applicable operating instructions.

Warranty Information

Each instrument is backed by the standard Proceq warranty and extended warranty options.

- » Electronic portion of the instrument: 24 months
- » Mechanical portion of the instrument: 6 months

 Click on the Proceq subsidiaries for more information

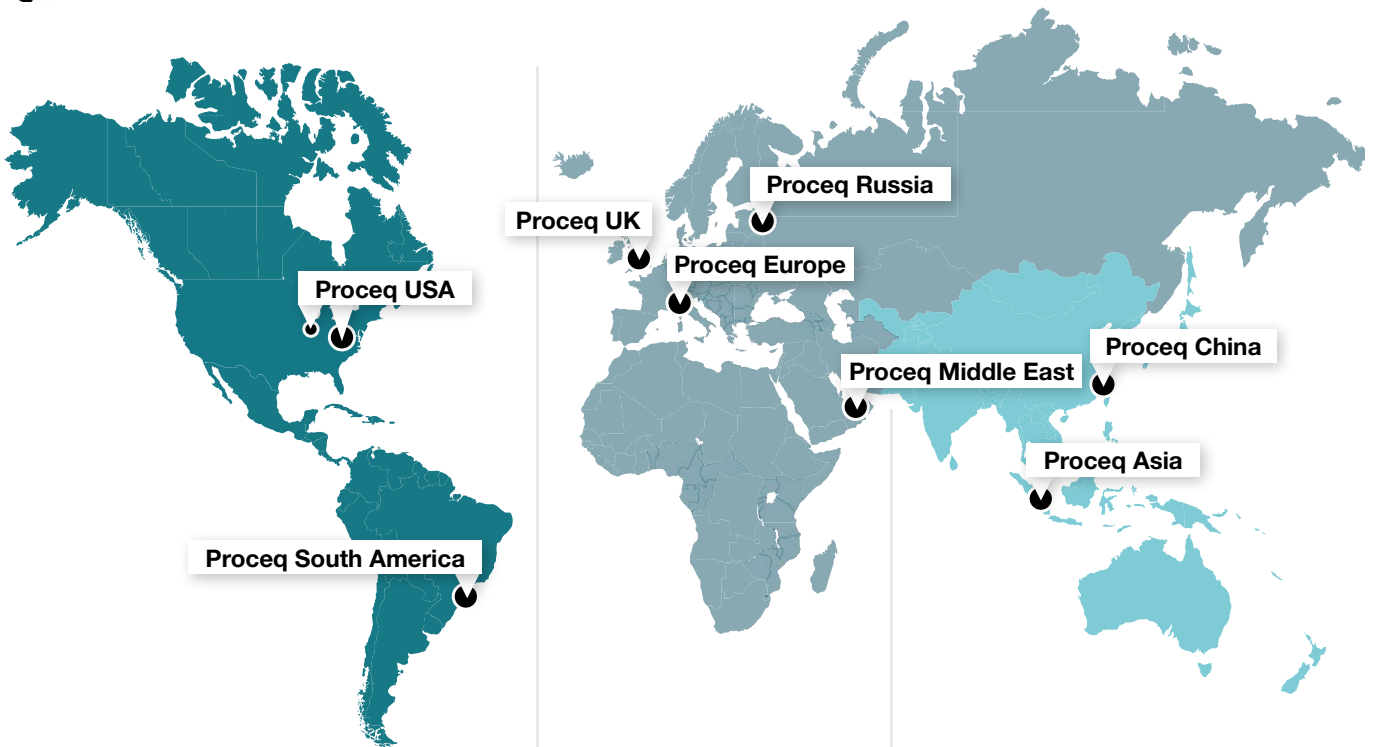

Proceq USA

Aliquippa, Pittsburgh, USA
Phone +1 724 512 0330
Fax +1 724 512 0331
info-usa@proceq.com

Gurnee, Chicago, USA
Phone +1 847 623 9570
Fax +1 847 623 9580
info-usa@proceq.com

Proceq South America

São Paulo, Brasil
Phone +55 11 3083 38 89
info-southamerica@proceq.com

Proceq Europe

Schwerzenbach, Switzerland
Phone +41 43 355 38 00
Fax +41 43 355 38 12
info-europe@proceq.com

Proceq UK

Bedford, UK
Phone +44 12 3483 4515
info-uk@proceq.com

Proceq Russia

St. Petersburg, Russia
Phone +7 812 448 35 00
Fax +7 812 448 35 00
info-russia@proceq.com

Proceq Middle East

Sharja, United Arab Emirates
Phone +971 6 557 8505
Fax +971 6 557 8606
info-middleeast@proceq.com

Proceq Asia

Singapore
Phone +65 6382 3966
Fax +65 6382 3307
info-asia@proceq.com

Proceq China

Shanghai, China
Phone +86 21 63177479
Fax +86 21 63175015
info-china@proceq.com



 E-Shop USA

 E-Shop Europe

 E-Shop Asia



Globally organized seminars to help you learn more about our products and applications.
Contact your local representative for further information.

Proceq SA

Ringstrasse 2
8603 Schwerzenbach
Switzerland

81035601E ver 03 2016 © Proceq SA, Switzerland. All rights reserved.

